



FOR MORE
INFORMATION

**MADE
IN
GERMANY**

VISUAL INSPECTION HAS EVOLVED

VUMAN[®] **E3**⁺
dition

THE LATEST GENERATION OF THE ULTIMATE LONG RANGE VIDEOSCOPE INSPECTION SYSTEM

PERFECT VISION FOR EVERY WORKING LENGTH

The new VUMAN E3/E3+ is specifically designed for long range inspections of up to 30 meters. The unique patented REMOTE FOCUS system incorporated into the VUMAN system ensures perfect documentation results (from $<1\text{mm}$ to ∞) without the need to extract the videoprobe and change lenses. This will reduce the inspection duration, user fatigue and save both time and money. The proprietary hybrid, high power, polymer dual LED illumination system provides class leading, homogenous illumination and excellent colour temperature.



X-WAY ARTICULATION

Joystick controlled, pneumatic, computer controlled 4 way articulation system with on board micro-compressor.



REMOTE FOCUS

Patented lens technology allowing for full focal control at the tip of the video-probe from the VUSCREEN unit slider. Infinitely adjustable and allows for range of $30\mu\text{m}$ to ∞ . No need to withdraw videoprobe and exchange lenses.



BATTERY POWERED

Powerful modular NiMH battery power for maximum portability. Charges in use if on mains. Integrated alert for low batt. Seamless change between battery and mains. IATA air transport compliant.



HIGH POWER DUAL LED LIGHT SOURCE

Dual high power LED's feed light into two separate polymer light bundles to provide class leading levels of light. Each LED can be independently controlled to allow for increased contrast or avoid any reflection issues. Integrated 'boost' function for clear visualisation in large cavities.

VUMAN® *E3⁺* dition



HIGH QUALITY INSPECTIONS IN REAL TIME

DESIGNED SPECIFICALLY FOR LONG
RANGE INSPECTION

The new VUSCREEN Touchscreen unit combines PPE-compatibility with an intuitive user interface and advanced software features. It offers perfect camera control in any situation and renders a crystal clear image onto the screen. Record videos in full resolution and take images for later analysis with a simple push of a button.



VUSCREEN CONTROL UNIT

Unique and portable LCD control unit with 10.4" LED backlight touch screen. Control your INVIZ® probe and all features via touch screen and direct access buttons.



INTEGRATED SOLID STATE HARD DRIVE

Store your images and video securely and safely on to the integrated solid state hard drive (up to 80 hours of videos and/or thousands of images).



MEDIA AND DATA CAPTURE

Record high resolution videos and images with personalized text entries, reference charts or customer logos. Manage all inspection data in the customizable file manager and export your data to USB for further processing.



CARBON FIBRE CONSTRUCTION

Designed to be robust and durable as well as high performance, the VUMAN and VUSCREEN both have a carbon fibre housing with elasto-polymer bumpers.



MEASUREMENT FUNCTION

Integrated measurement system, allowing for accurate measurement of linear distance, radius, circumference and area. Save the images with measurement data and you can re-measure as required.



THE HIGH-END VIDEOSYSTEM FOR REMOTE VISUAL INSPECTIONS

New dual high power LED light source for precise remote visual inspections, long range X-WAY video probes for an increased application range and extended software features for even better inspection results.



PATENTED DRUM STORAGE

Enjoy full X-WAY probe articulation with the majority of your probe stored in the patented drum storage. Avoid tripping hazard and maintain clean working environment.



CARBON CONSTRUCTION

Robust, compact and lightweight, optimized for industrial environment.



NO EXTERNAL AIR SUPPLY

Full X-WAY articulation with no external air supply or cartridge due to the integrated micro compressor.



HOT SHOP REPAIR & SPARE PARTS

100% customer commitment: Our Hot Shop Service meets the demands of all our customers, even those in the most demanding industries. We are ISO 9001 and KTA 1401 compliant and are always constantly improving our products & service.

LIGHT AND PRECISE

CLASS LEADING 4-WAY ARTICULATION

The proprietary pneumatic X-WAY articulation system allows for full 4 axis (up/down/left/right) articulation of all VUMAN X-WAY probes.

The system is controlled by the joystick on the VUSCREEN control unit and is powered by an integrated, computer controlled microcompressor, so there is no need for external air sources or external gas canisters. The pneumatic connection to the probe is integrated into the connection block and as the system is pneumatic, X-WAY articulation can be applied to probes of up to 30m in length and can be used with the probe 'on-drum'.

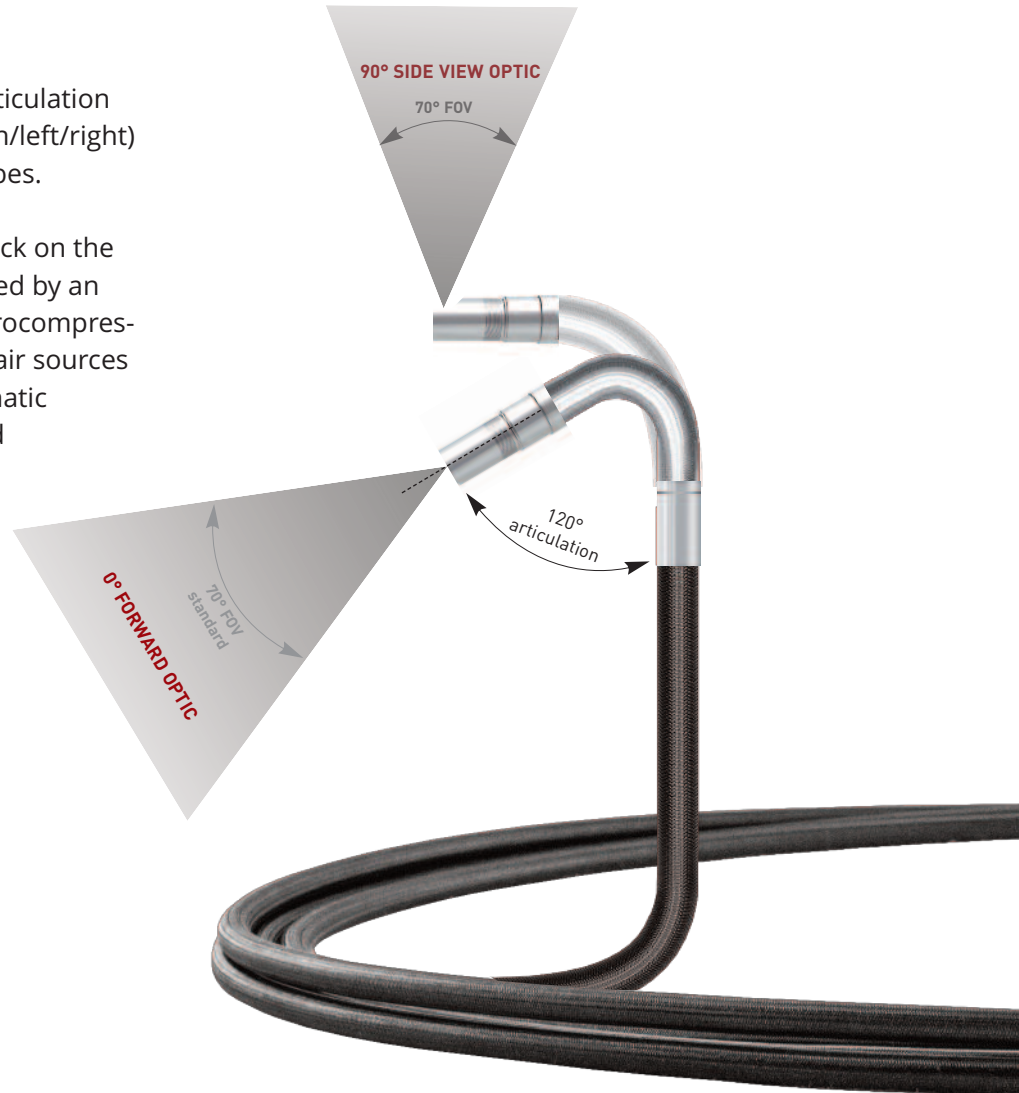

VUMAN® INTERCHANGEABLE VIDEOPROBES

A TOOL FOR EVERY TASK



INTERCHANGEABLE VIDEO PROBE INVIZ® 6

INTERCHANGEABLE VIDEO PROBE INVIZ® 6

INTERCHANGEABLE VIDEO PROBE INVIZ® 8

INTERCHANGEABLE VIDEO PROBE INVIZ® 8 X-WAY

INTERCHANGEABLE VIDEO PROBE INVIZ® REVOLVER 12.7

A unique feature allowing quick and simple exchange of probes with the base unit if your inspection application requires the use of different diameters or lengths of probes (a very wide range is available). This avoids the need to carry multiple base units, ensures modular repair capability and allows for a very cost effective solution. In the event of use within a contaminated environment (i.e. chemical, nuclear, food, pharmaceutical), it also allows for the probe to be removed or disposed of without having to clean or dispose of the entire system.

- ❑ Scan your application step by step with two probe articulation types and the probe lock for precise camera head control. The probe head either remains in the current position or moves back to 0°.
- ❑ All interchangeable VUMAN® video probes are available with working lengths up to 30 m / 100 ft. for maximum range.
- ❑ The functional design of our interchangeable VUMAN® video probes is based on the feedback of our customers and the extensive experience of our own industrial inspection service.
- ❑ Over 100 times more flexibility and bending radius, still remaining excellent torsion and friction characteristics due to the polyurethane stainless steel composite construction.
- ❑ The patented Remote Focus technology is offering the best focus range on the market from <math><1\text{ mm}</math> to - ❑ The INVIZ® Revolver 12.7 is the most efficient and effective tool available for extensive orbital tube and weld inspections. Adjustable and endless 360° camera head rotation (clockwise / counter-clockwise), this small motorized camera head offers excellent continuous orbital weld & wall inspections.
- ❑ The boost of the dual high power LED light source provides outstanding illumination in every application. Balance two separately adjustable light outputs increasing failure analysis capabilities, reducing reflections and thus improving inspection results. Increase safety and productivity. A light source failing is no longer ending in sightless and risky probe exits and work stops.
- ❑ Non articulating VUMAN® video probes are designed for heavy duty tube inspections over long periods. Operated with its centering devices, these video probes with its spring loaded probe tip are an economically unbeatable and robust remote visual inspection system for your tube inspection needs.

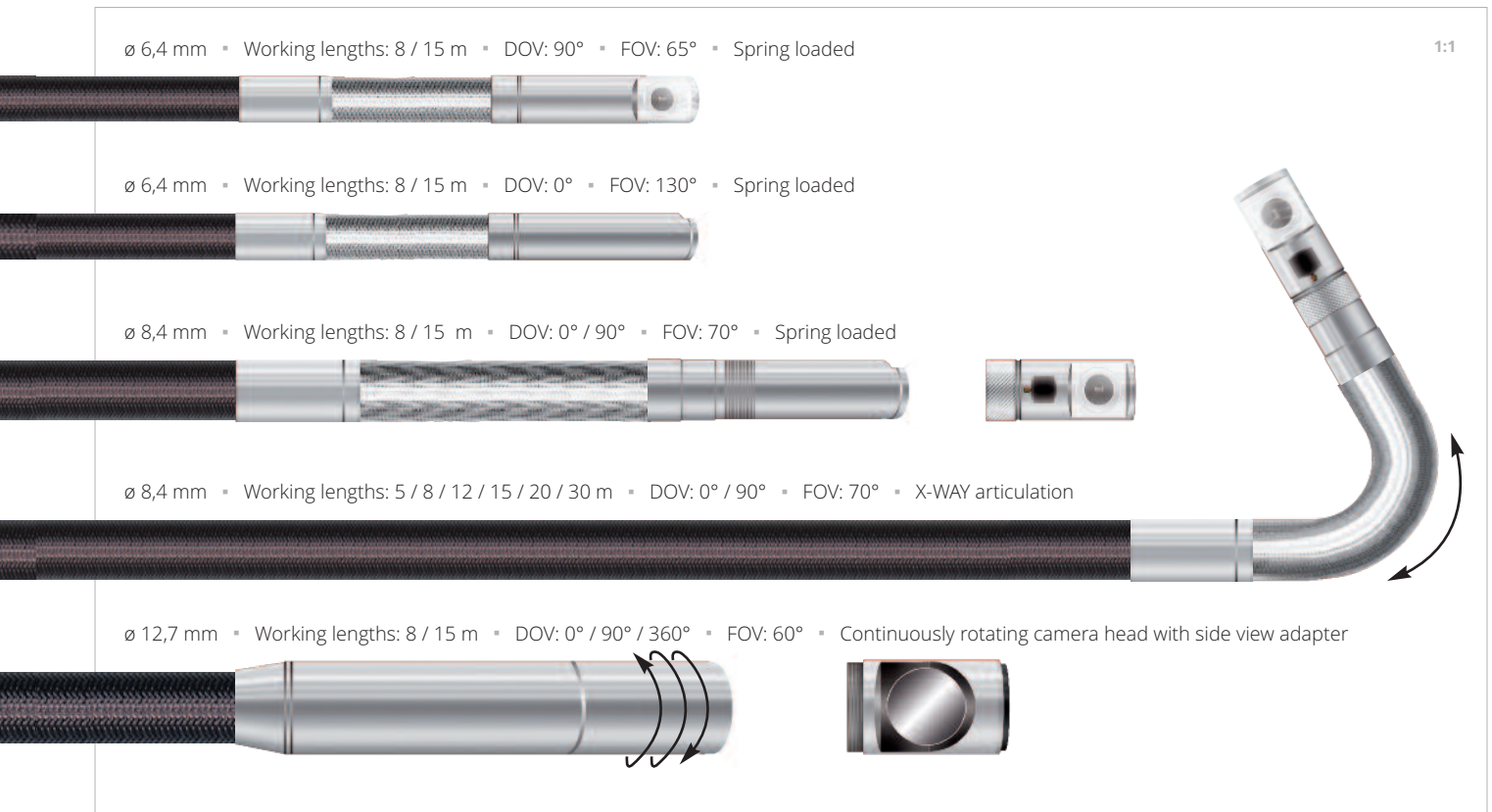



BASE UNIT	INVIZ® VUMAN® E3	INVIZ® VUMAN® E3 X-WAY	INVIZ® VUMAN® E3+	INVIZ® VUMAN® E3+ X-WAY
Dimensions in mm / inch	(W) 335 x (H) 410 x (D) 275 (W) 13.19 x (H) 16.14 x (D) 10.83	(W) 335 x (H) 410 x (D) 275 (W) 13.19 x (H) 16.14 x (D) 10.83	(W) 335 x (H) 410 x (D) 275 (W) 13.19 x (H) 16.14 x (D) 10.83	(W) 335 x (H) 410 x (D) 275 (W) 13.19 x (H) 16.14 x (D) 10.83
Weight in kg / lbs	8.5 / 18,7	10 / 22	8.5 / 18.7	10 / 22
X-WAY drive	-	Integrated compressor, maintenance free.	-	Integrated compressor, maintenance free.
Probe length	max. 20 m	max. 20 m	max. 20 m	max. 20 m or 30 m*
Construction	Aluminum–Carbon fiber with elastomer bumpers	Aluminum–Carbon fiber with elastomer bumpers	Aluminum–Carbon fiber with elastomer bumpers	Aluminum–Carbon fiber with elastomer bumpers
LED dual light source	Lifetime guarantee High efficiency LED illumination 7.8 Watt Color temperature 6.500 K	Lifetime guarantee High efficiency LED illumination 7.8 Watt Color temperature 6.500 K	Lifetime guarantee High efficiency LED illumination 7.8 Watt Color temperature 6.500 K	Lifetime guarantee High efficiency LED illumination 7.8 Watt Color temperature 6.500 K
System memory	10GB SSD	10GB SSD	80GB SSD	80GB SSD
Connectors	USB 3.0 12V(DC) / 750mA Aux-Out Optional external compressed air Rechargeable battery	USB 3.0 12V(DC) / 750mA Aux-Out Optional external compressed air Rechargeable battery	USB 3.0 12V(DC) / 750mA Aux-Out Optional external compressed air Rechargeable battery	USB 3.0 12V(DC) / 750mA Aux-Out Optional external compressed air Rechargeable battery
Video input	PAL / NTSC, Composite, S-Video	PAL / NTSC, Composite, S-Video	PAL / NTSC, Composite, S-Video	PAL / NTSC, Composite, S-Video
Video output	HDMI	HDMI	HDMI, optionally with additional TV-Out (Composite, S-Video)	HDMI, optionally with additional TV-Out (Composite, S-Video)
AC input	90V(AC) - 264V(AC) 47Hz - 63Hz max. 140 Watt	90V(AC) - 264V(AC) 47Hz - 63Hz max. 220 Watt	90V(AC) - 264V(AC) 47Hz - 63Hz max. 150 Watt	90V(AC) - 264V(AC) 47Hz - 63Hz max. 240 Watt
Environmental specifications	Operation: -15°C (+5°F) to +48°C (+118°F) Storage: -25°C (-13°F) to +65°C (+150°F) Relative humidity: max. 95%, non condensing	Operation: -15°C (+5°F) to +48°C (+118°F) Storage: -25°C (-13°F) to +65°C (+150°F) Relative humidity: max. 95%, non condensing	Operation: -15°C (+5°F) to +48°C (+118°F) Storage: -25°C (-13°F) to +65°C (+150°F) Relative humidity: max. 95%, non condensing	Operation: -15°C (+5°F) to +48°C (+118°F) Storage: -25°C (-13°F) to +65°C (+150°F) Relative humidity: max. 95%, non condensing
Software Kit	E3	E3	E3+	E3+
Software	<p>Default user Multi language user interface E-Manual White balance Probe articulation display** Articulation mode (absolute) Text color (black / white) Text background color (black / white) Copy / delete files Play / pause image capture (JPG) video capture (AVI)</p> <p>Individual user 1-9 Multi language user interface E-Manual Dual LED illumination balance 8x (left/right)* Dual LED illumination boost** Brightness / contrast Digital image processing (Presets)** Long time exposure Flip / Mirror / Zoom Rotate (clockwise / counter-clockwise) Individual reference chart / customer logo Point marker Articulation mode (absolute / relative) Adjustable video recording length image capture (JPG / BMP) video capture (AVI / MPG) Continuous image capture** 4 status bars Date & time Item positioning Advanced data management Measure distances between two points** Measure circles (radius, diameter, circumference, circular area)** Assi- stance (grid & reference quality)** Save / move / zoom / delete measurements**</p>			

* 30 Meter version of INVIZ® VUMAN® E3+ X-WAY only available with HDMI and additional TV-Out (Composite, S-Video)

** Features only available with V3 VUMAN® probes and base units from V3.

WARNING! Not for medical use. Never use close to electrical facilities, or in hazardous or explosive environments. US or EUROPEAN patents may apply to all INVIZ® and VUCAM® products. Microsoft®, Windows® are either registered trademarks or trademarks of Microsoft Corporation in the United States and / or other countries.
© Copyright, viZaar AG. Illustrations may differ from the original. Subject to technical modifications and errors. All rights reserved.



VUSCREN CONTROL UNIT

Dimensions in mm / inch	(W) 320 / 12.6 x (H) 30 / 1.18 x (D) 230 / 9.06
Weight in kg / lbs	1.6 / 3.5
Mounting	On base unit: integrated mounting Portable: shoulder strap
Display	10.4" touch screen Transreflective LED backlight Viewing angle all directions +/- 80°
Contrast	700:1
Brightness	700 cd/m²
Colors	True Color
Operation	Touch screen incl. five direct access buttons and joystick (approved for operation with working gloves).
Construction	Carbon fiber design with all around elastomer bumper; 2.5 m / 8.2 ft cable designed for harsh environments
Functions	Image recording Video recording Freeze Toggle function Articulation control Articulation lock Probe lock Remote Focus slide bar Illumination slide bar

IMPROVED BATTERY PACK





HALF THE WEIGHT, DOUBLE THE POWER.

Maximum portability and flexibility is provided by the new and improved NiMH modular battery pack. It offers the best performance and safety on the market and is air transportable. Operation of up to 3 hours on battery alone* and seamless changeover between battery and mains.







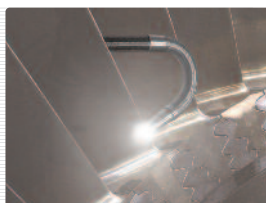

**SAFE TO TRANSPORT -
NO LITHIUM!**

* Note: The durability with battery operation depends on the probe type, battery age, charging condition and system usage as well as the environmental temperature.

					
INVIZ® INTERCHANGEABLE VIDEO PROBES	6 SIDE VIEW	6 STRAIGHT VIEW	8 X-WAY	8	REVOLVER 12.7
Probe diameter in mm / inch	6.4 / 0.25	6.4 / 0.25	8.4 / 0.33	8.4 / 0.33	12.7 / 0.5
Probe length in m / ft.	8 / 26.3 15 / 49.3	8 / 26.3 15 / 49.3	5 / 16.4 8 / 26.3 12 / 39.4 15 / 49.3 20 / 65.6 30 / 100	8 / 26.3 15 / 49.3	8 / 26.3 15 / 49.3
Probe length extension (up to 30 m / 100 ft.)	✓	✓	-	-	✓
Weight in g / lbs	820 / 1.8 1140 / 2.5	820 / 1.8 1140 / 2.5	920 / 2.0 990 / 2.2 1175 / 2.6 1360 / 3.0 2330 / 5.4 3300 / 7.2	870 / 1.9 1240 / 2.7	1120 / 2.5 1520 / 3.4
X-WAY camera head articulation up / down / left / right	-	-	+/- 90° to +/- 120°	-	-
Remote Focus (RF)	✓	-	✓	✓	-
Direction of view (DOV)	90°	0°	0° / 90°	0° / 90°	90° / 360°
Field of view (FOV)	65°	130°	70°	70°	60°
Focus range	< 1 mm to ∞	7 mm to ∞	< 1 mm to ∞	< 1 mm to ∞	< 1 mm to ∞
Resolution 440.000 px, (H) 752 x (V) 582	✓	✓	✓	✓	✓
Mounting for centering device	✓	✓	✓	✓	✓
Mounting for side view adapter	-	-	✓	✓	✓
Self centering supple bending section at camera head	✓	✓	-	✓	-
Hard wearing stainless steel braid on polyurethan probe	✓	✓	✓	✓	✓
Watertight up to 1.5 bar / 14 psi	✓	✓	✓	✓	-
Splash waterproof	✓	✓	✓	✓	✓
Centering device kit included in scope of delivery	✓	-	-	-	✓

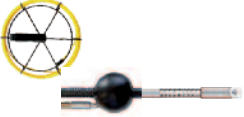

ACCESSORIES

<p>Transport case</p>	<p>Dimensions in mm / inch: (W) 635 / 25 x (H) 510 / 20.08 x (D) 365 / 14.37. Weight (empty): 8,7 kg / 19,1 lbs. Transport case with wheels.</p>	
<p>Transport case INVIZ® spare probe</p>	<p>Dimensions in mm / inch: (W) 415 / 16.34 x (H) 465 / 18.31 x (D) 190 / 7.48. Weight (empty): 3,25 kg / 7.16 lbs. Transport case for spare probe.</p>	
<p>Option side view adapter</p>	<p>Side view prism for 8 mm interchangeable probes and side view adapter for 12.7 mm interchangeable probes.</p>	
<p>Option centering device kit</p>	<p>INVIZ® VUMAN® 8 mm X-WAY, Ø in mm / inch: 60 / 2.36 44 / 1.73 34 / 1.34 24 / 0.94 17 / 0.67 INVIZ® VUMAN® 8 mm non articulating, Ø in mm / inch: 60 / 2.36 44 / 1.73 34 / 1.34 24 / 0.94 17 / 0.67 INVIZ® Revolver 12.7 mm, Ø in mm / inch: 60 / 2.36 46 / 1.81 36 / 1.42 26 / 1.02</p>	
<p>Option pushing aid</p>	<p>PE coated glass fiber pushing aids with 4.5 mm / 0.17" for up to 30 m / 100 ft. video probe length.</p>	
<p>Option battery incl. charging unit</p>	<p>Capacity of coldness resistant NiMh: 9 Ah, 24 Volt. Operation time: approx. 3 h. Operation environment: 0°C to +48°C (32.0°F to +118.4°F).</p>	

All specifications are subject to change without notice due to technical progress.



VUMAN[®] E3⁺ dition

EXPANDING YOUR VU[®]



viZaar industrial imaging AG

Hechinger Straße 152
72461 Albstadt / Germany
Tel.: +49 7432 98375-0
Fax: +49 7432 98375-50
Freecall 0800 3600371 (only within Germany)
www.vizaar.de
info@vizaar.com

viZaar industrial imaging AG Vertriebs- und Dienstleistungszentrum Rhein-Main

Fürfurter Straße 105
65606 Villmar-Aumenau / Germany
Tel.: +49 6474 8837-70
Fax: +49 6474 8837-90

viZaar industrial imaging AG Vertriebs- und Dienstleistungszentrum Nord

Am Neuendeich 52
25348 Glückstadt / Germany
Tel.: +49 4124 60819-40
Fax: +49 4124 60819-49

viZaar industrial imaging AG Vertriebs- und Dienstleistungszentrum West

Burgstraße 27
46348 Raesfeld / Germany
Tel.: +49 170 5703130



viZaar Industrial Imaging - North America

4533 Gibsonia Road
PA 15044 Gibsonia / USA
Tel.: +1 724 449-3270
Fax: +1 724 449-3273
www.vizaar-na.com
info@vizaar-na.com



viZaar Russia & CIS

197022, St. Petersburg,
Professora Popova 37B
Russia
Tel.: +7 9852220677
www.vizaar.ru
info@vizaar.ru



viZaar South-East Asia Sdn. Bhd.

2A Lrg Desa Utama Jln Masjid Kayu
Ara PJU 6
47400 Petaling Jaya Selangor, Malaysia
Tel.: +603 772 217-10
Fax: +603 772 217-10
www.vizaarsea.com.my
info@vizaarsea.com.my



FORT SA

3 rue Lambert
Parc Lavoisier
91410 Dourdan / France
Tel.: +33 1608 11818
Fax: +33 1645 99573
www.fort-fr.com
info@fort-fr.com

Authorised sales and service distributor of viZaar[®]: